

# LINEAR

COLLECTION



PANEL, CABLE AND TUBE SYSTEMS



A NOVO Building Products Company

# PANEL SYSTEM

This collection consists of preassembled panels resulting in a very simplified installation process for open tread stairs, kneewall stairs and level run applications. This system is for interior use only.

Our Linear Panels can be pre-built to fit and only need a few screw holes drilled for installation. No glue needed, no sanding, no drilling of baluster holes, no marking and cutting to fit.

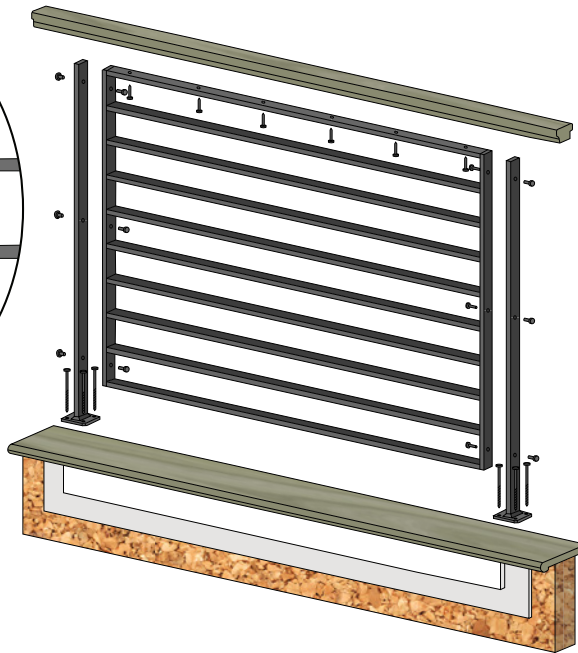
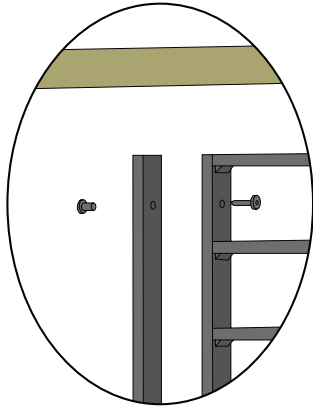

Installation Instructions are available on our website [www.LJSmith.com](http://www.LJSmith.com)

Installation hardware included with panels and posts:

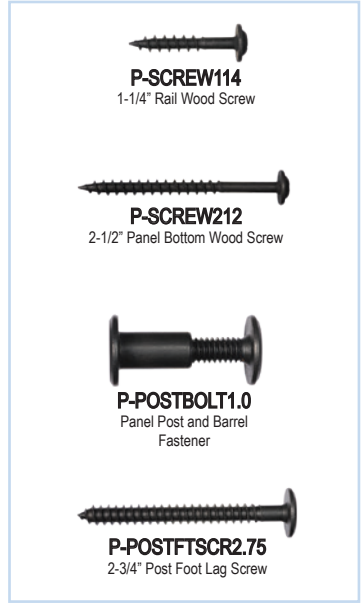

1/2" x 1 1/2" rectangular tube construction with .065 wall thickness

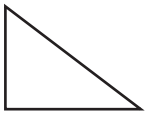

Designed for 7 1/2" Rise and 10" Run (36.9°)

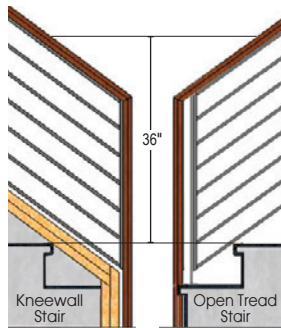

36" Rake rail height and 36", 39" or 43" level run rail heights. Rail heights may vary due to field conditions or preferences

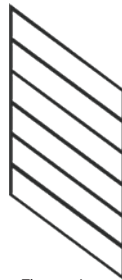

Five rake panel widths

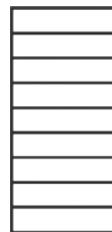

Seven level panel widths



Standard finish is Low Sheen Black. Other powder coat and Pantone paint colors can be quoted.

## Kneewall Stair Panels

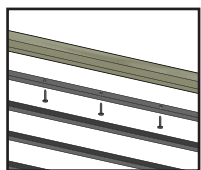

Every rake and level panel is predrilled on the top rung and comes with screws for attachment to the handrail. Screws are also included for the bottom of each panel.

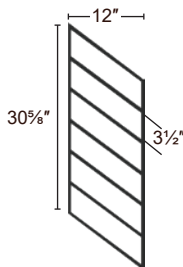

**PR-K1236**  
15"  
Actual Rake Length

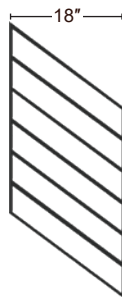

**PR-K1836**  
22 1/2"  
Actual Rake Length

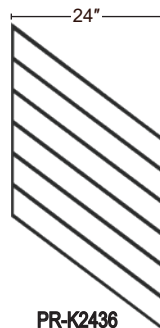

**PR-K2436**  
30"  
Actual Rake Length

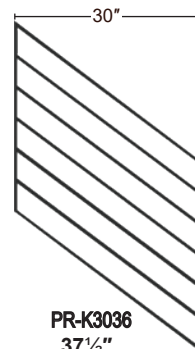

**PR-K3036**  
37 1/2"  
Actual Rake Length

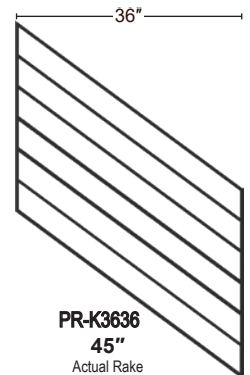

**PR-K3636**  
45"  
Actual Rake Length

## Open Tread Stair Panels

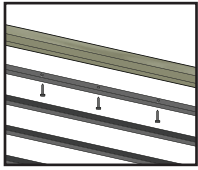

Every rake and level panel is predrilled on the top rung and comes with screws for attachment to the handrail. Screws are also included for the bottom of each panel.

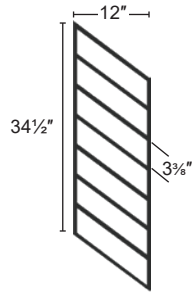

**PR-O1236**  
15"  
Actual Rake  
Length

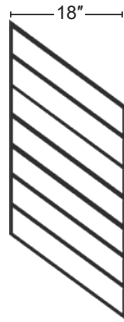

**PR-O1836**  
22 1/2"  
Actual Rake  
Length

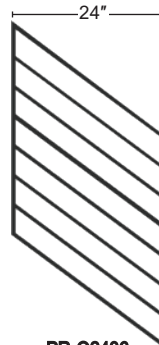

**PR-O2436**  
30"  
Actual Rake  
Length

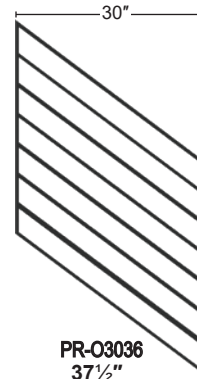

**PR-O3036**  
37 1/2"  
Actual Rake  
Length

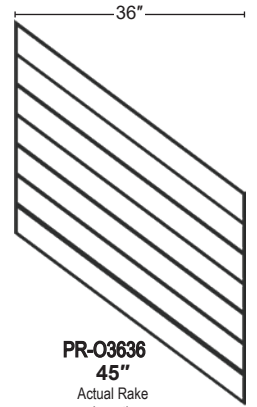

**PR-O3636**  
45"  
Actual Rake  
Length

## Level Run Panels

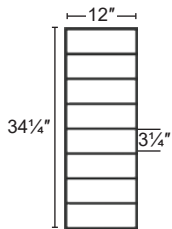

**PL-CE1239**  
39" Rail Height  
Curb Wall or Elevated



**PL-CE1839**  
39" Rail Height  
Curb Wall or Elevated



**PL-CE2439**  
39" Rail Height  
Curb Wall or Elevated

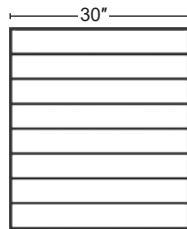

**PL-CE3039**  
39" Rail Height  
Curb Wall or Elevated

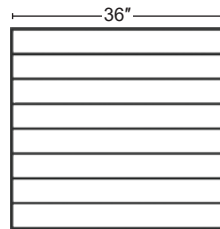

**PL-CE3639**  
39" Rail Height  
Curb Wall or Elevated

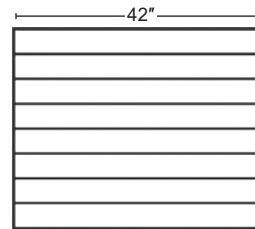

**PL-CE4239**  
39" Rail Height  
Curb Wall or Elevated

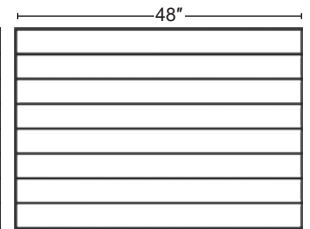

**PL-CE4839**  
39" Rail Height  
Curb Wall or Elevated

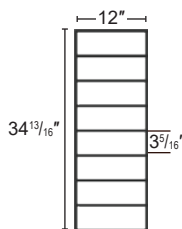

**PL-F1236**  
36" Rail Height  
Flush Mount



**PL-F1836**  
36" Rail Height  
Flush Mount



**PL-F2436**  
36" Rail Height  
Flush Mount

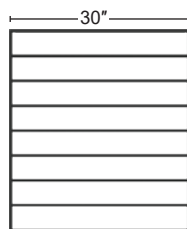

**PL-F3036**  
36" Rail Height  
Flush Mount

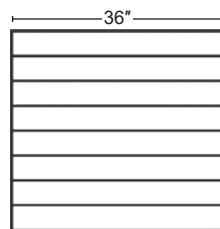

**PL-F3636**  
36" Rail Height  
Flush Mount

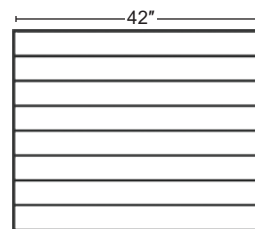

**PL-F4236**  
36" Rail Height  
Flush Mount

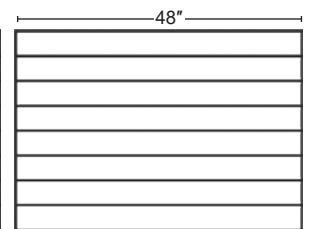

**PL-F4836**  
36" Rail Height  
Flush Mount

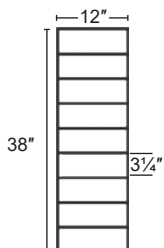

**PL-CE1243**  
43" Rail Height  
Curb Wall or Elevated



**PL-CE1843**  
43" Rail Height  
Curb Wall or Elevated



**PL-CE2443**  
43" Rail Height  
Curb Wall or Elevated



**PL-CE3043**  
43" Rail Height  
Curb Wall or Elevated

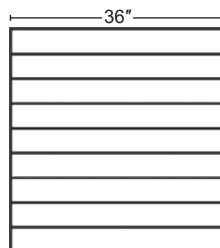

**PL-CE3643**  
43" Rail Height  
Curb Wall or Elevated

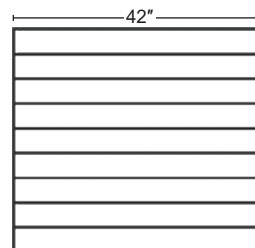

**PL-CE4243**  
43" Rail Height  
Curb Wall or Elevated

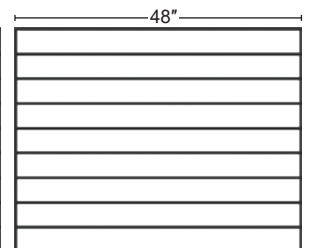

**PL-CE4843**  
43" Rail Height  
Curb Wall or Elevated

**PL-F1239**  
39" Rail Height  
Flush Mount

**PL-F1839**  
39" Rail Height  
Flush Mount

**PL-F2439**  
39" Rail Height  
Flush Mount

**PL-F3039**  
39" Rail Height  
Flush Mount

**PL-F3639**  
39" Rail Height  
Flush Mount

**PL-F4239**  
39" Rail Height  
Flush Mount

**PL-F4839**  
39" Rail Height  
Flush Mount

# PANEL SYSTEM

## Spacer Newels

Use to maintain spacing code between panels. Rake and Level Panel Runs cannot exceed 15' without a spacer Newel

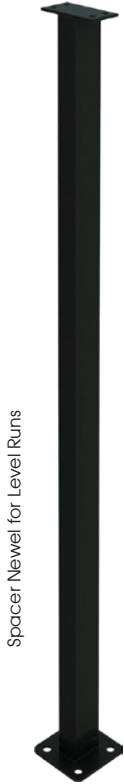

Spacer Newel for Level Runs

Level 4-Hole Foot Spacer Newel

**PL-F36NWL4H**  
1" x 1-1/2" x 34-13/16"  
36" Rail Height  
Flush Mount

**PL-E43NWL4H**  
1" x 1-1/2" x 41-1/4"  
43" Rail Height  
Elevated

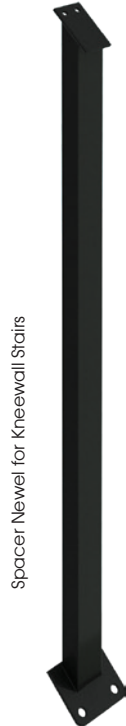

Spacer Newel for Kneewall Stairs

Kneewall 2-Hole Foot Spacer Newel

**PR-K36NWL2H**  
1" x 1-1/2" x 30-5/8"  
36" Rail Height

**PL-F39NWL4H**  
1" x 1-1/2" x 38"  
39" Rail Height  
Flush Mount

**PL-C39NWL4H**  
1" x 1-1/2" x 34-1/4"  
39" Rail Height  
Curb Wall

**PL-E39NWL4H**  
1" x 1-1/2" x 37-1/2"  
39" Rail Height  
Elevated

**PL-C43NWL4H**  
1" x 1-1/2" x 38"  
43" Rail Height  
Curb Wall

## Panel Posts



Panel Post for Level Runs and Open Tread Stairs

**P-POST2H**  
1/2" x 1-1/2" x 47"  
2-Hole Foot Plate



Panel Post for Level Runs and Open Tread Stairs. Often used at the end of a level run that ends near a wall.

**P-POST4H**  
1/2" x 1-1/2" x 47"  
4-Hole Foot Plate

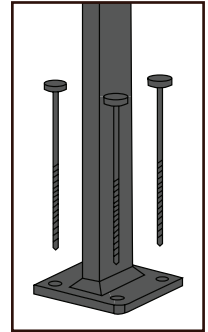

Each Spacer Newel and Panel Post comes with foot lag screws for attachment to the mounting surface. Spacer Newels also include wood screws for attachment to the handrail. Each Panel Post includes 3 Panel Post and Barrel Fasteners for attachment to the panel.



**P-SCREW114**  
1-1/4" Rail Wood Screw



**P-POSTFTSCR2.75**  
2-3/4" Post Foot Lag Screw



**P-POSTBOLT1.0**  
Panel Post and Barrel Fastener

Panel Posts are used to secure panels on open tread stairs and level runs when the panels are elevated above the floor.

## Panel Post Kit

The following kit is available to simplify the ordering of panel systems utilizing Panel Posts.

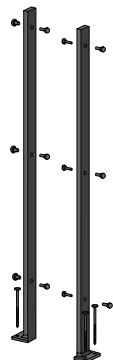

### P-POSTKIT2H

- Each kit includes:
- 2 Panel Posts with 2-Hole Foot Plate (P-POST2H)
  - 4 2-3/4" Post Foot Lag Screws (P-POSTFTSCR2.75)
  - 6 Post and Barrel Bolts (P-POSTBOLT1.0)

## Flush, Elevated and Curb Wall Details

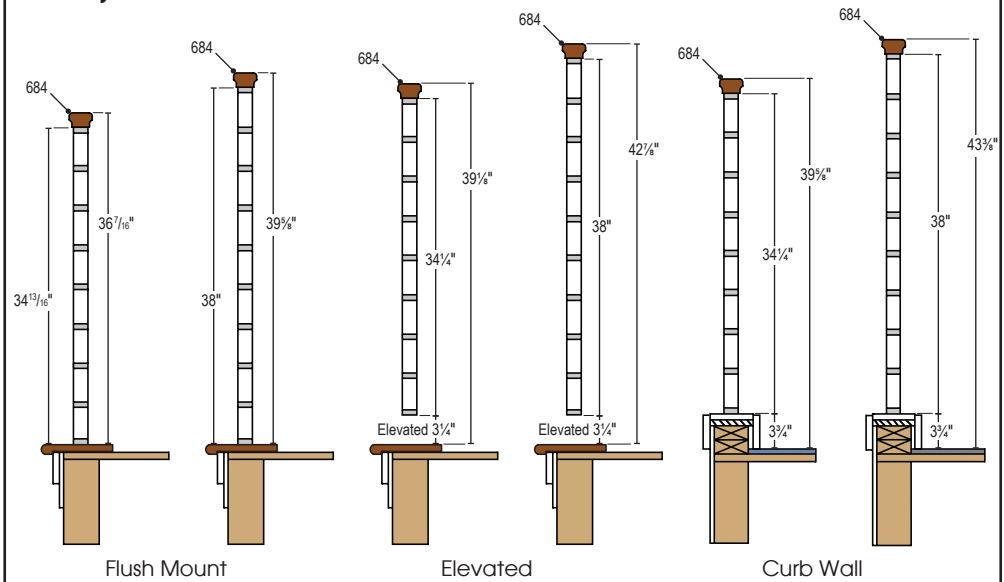

Stairway Anatomies

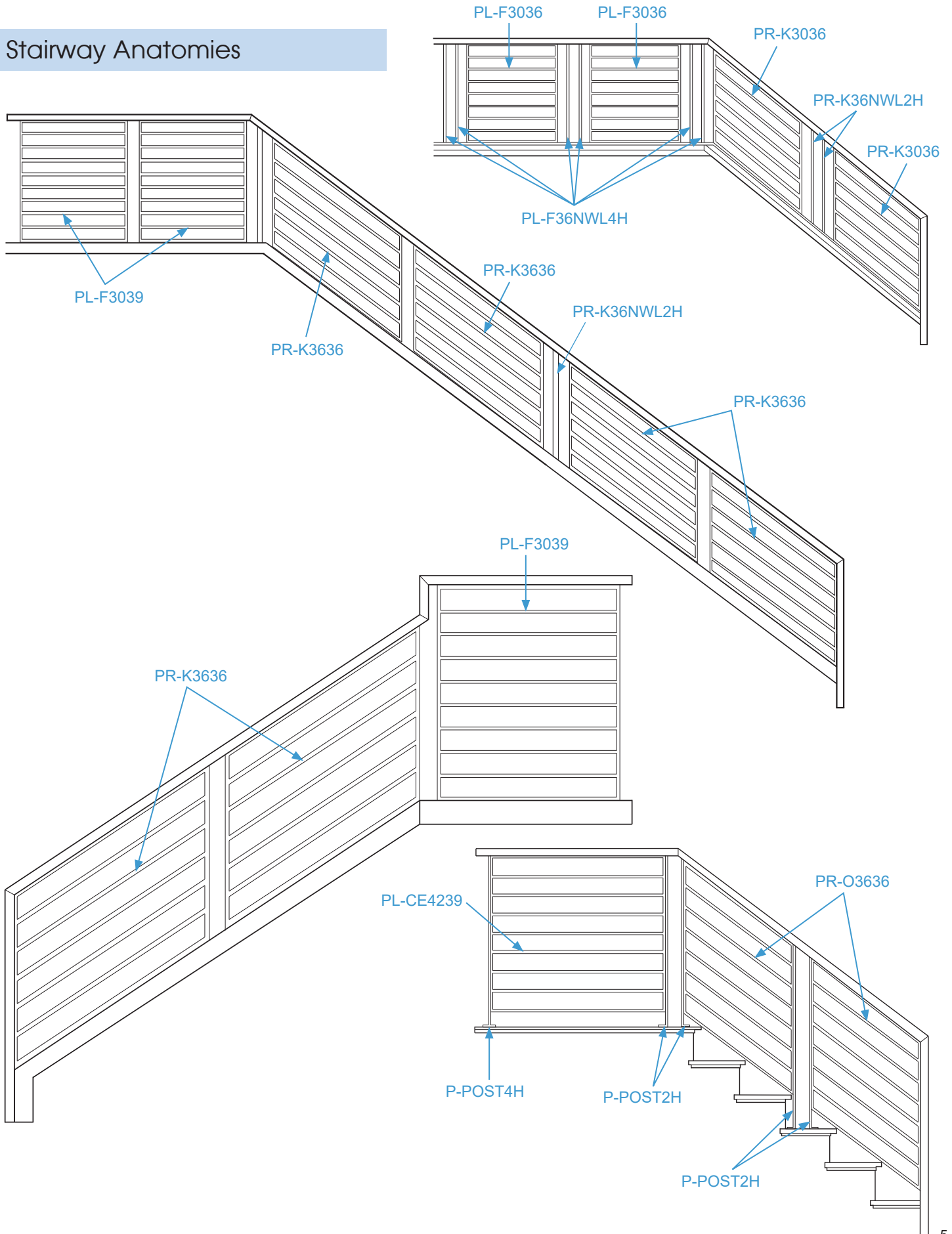

# METAL NEWELS FOR CABLE SYSTEM

## Stairway Open Tread Newels

## Stairway Kneewall Newels

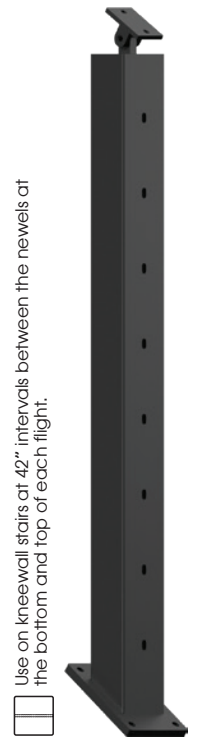
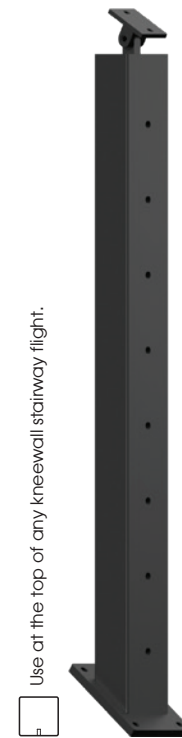
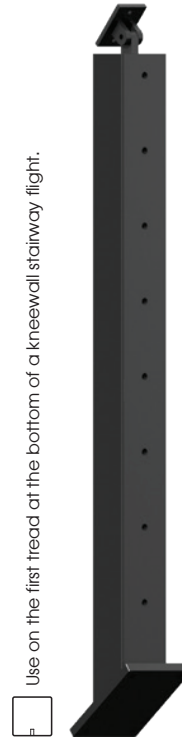
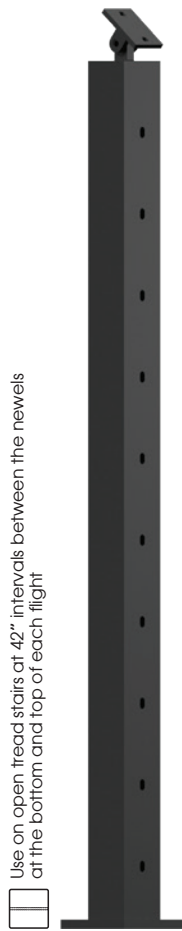
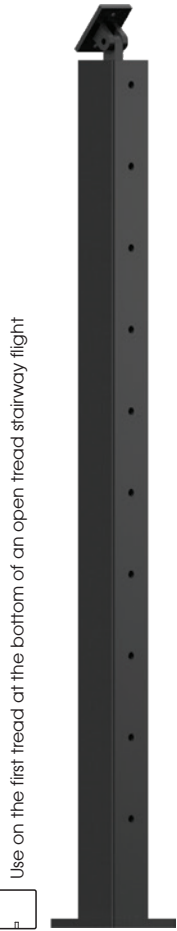

Rake Up  
10 Holes **CR-310U-36**  
2" x 35<sup>21</sup>/<sub>32</sub>"  
11 Holes **CR-310U-39**  
2" x 38<sup>21</sup>/<sub>32</sub>"

Rake Down  
**CR-310D-36**  
2" x 35<sup>21</sup>/<sub>32</sub>"  
**CR-310D-39**  
2" x 38<sup>21</sup>/<sub>32</sub>"

Rake Pass Through  
**CR-320-36**  
2" x 35<sup>21</sup>/<sub>32</sub>"  
**CR-320-39**  
2" x 38<sup>21</sup>/<sub>32</sub>"

Rake Up  
8 Holes **CR-KW310U-36**  
2" x 28<sup>7</sup>/<sub>16</sub>"  
9 Holes **CR-KW310U-39**  
2" x 31<sup>7</sup>/<sub>16</sub>"

Rake Down  
**CR-KW310D-36**  
2" x 28<sup>7</sup>/<sub>16</sub>"  
**CR-KW310D-39**  
2" x 31<sup>7</sup>/<sub>16</sub>"

Rake Pass Through  
**CR-KW320-36**  
2" x 28<sup>7</sup>/<sub>16</sub>"  
**CR-KW320-39**  
2" x 31<sup>7</sup>/<sub>16</sub>"

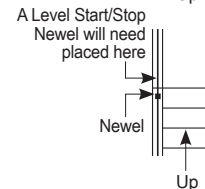
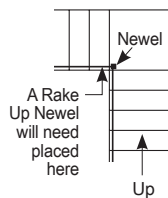
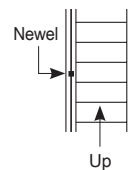
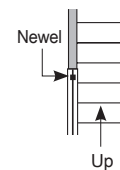
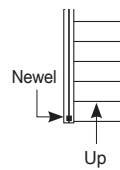
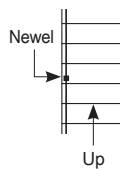
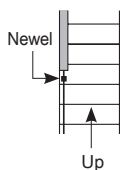
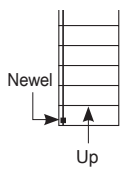

Each Metal Newel Post comes with 2 1/2" foot lag screws for attachment to the mounting surface and 1" wood screws for attachment to the handrail.

Installation Instructions are available on our website  
[www.LJSmith.com](http://www.LJSmith.com)

See page 14 for cable, cable fittings and cable accessories. This system is for interior or exterior use.

**IMPORTANT: Our Metal Newels and Cable System is designed for stairways with 7-1/2" rise and 10" run (approx. 36.9°)**



## Level Run Newels

## Transition Newels-Rake to Level Run

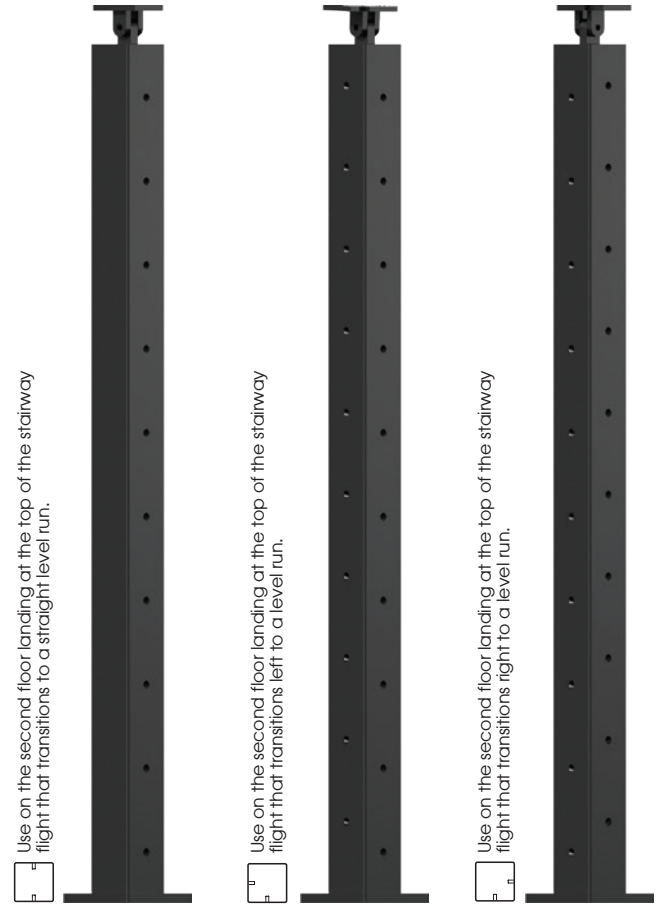
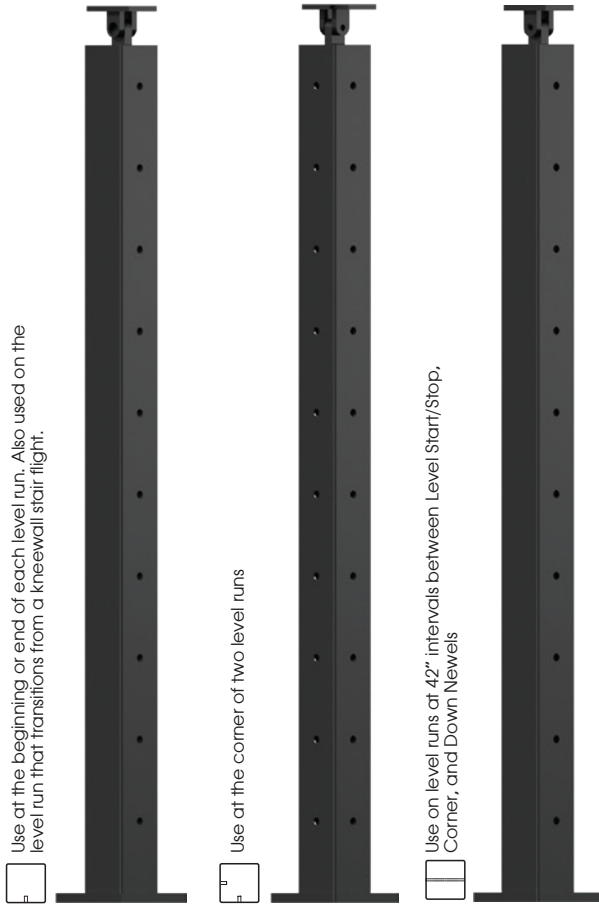

	Level Start/Stop	Level Corner	Level Pass Through
10 Holes	<b>CL-310-36</b> 2" x 34 <sup>3</sup> / <sub>8</sub> "	<b>CL-310C-36</b> 2" x 34 <sup>3</sup> / <sub>8</sub> "	<b>CL-320-36</b> 2" x 34 <sup>3</sup> / <sub>8</sub> "
11 Holes	<b>CL-310-39</b> 2" x 37 <sup>3</sup> / <sub>8</sub> "	<b>CL-310C-39</b> 2" x 37 <sup>3</sup> / <sub>8</sub> "	<b>CL-320-39</b> 2" x 37 <sup>3</sup> / <sub>8</sub> "
12 Holes	<b>CL-310-42</b> 2" x 40 <sup>3</sup> / <sub>8</sub> "	<b>CL-310C-42</b> 2" x 40 <sup>3</sup> / <sub>8</sub> "	<b>CL-320-42</b> 2" x 40 <sup>3</sup> / <sub>8</sub> "

	Level Down/Straight	Level Down/Left	Level Down/Right
10 Holes	<b>CL-310DS-36</b> 36 rake to 36 level 2" x 34 <sup>3</sup> / <sub>8</sub> "	<b>CL-310DL-36</b> 36 rake to 36 level 2" x 34 <sup>3</sup> / <sub>8</sub> "	<b>CL-310DR-36</b> 36 rake to 36 level 2" x 34 <sup>3</sup> / <sub>8</sub> "
10&11 Holes	<b>CL-310D36S-39*</b> 36 rake to 39 level 2" x 37 <sup>3</sup> / <sub>8</sub> "	<b>CL-310D36L-39*</b> 36 rake to 39 level 2" x 37 <sup>3</sup> / <sub>8</sub> "	<b>CL-310D36R-39*</b> 36 rake to 39 level 2" x 37 <sup>3</sup> / <sub>8</sub> "
10&12 Holes	<b>CL-310D36S-42*</b> 36 rake to 42 level 2" x 40 <sup>3</sup> / <sub>8</sub> "	<b>CL-310D36L-42*</b> 36 rake to 42 level 2" x 40 <sup>3</sup> / <sub>8</sub> "	<b>CL-310D36R-42*</b> 36 rake to 42 level 2" x 40 <sup>3</sup> / <sub>8</sub> "
11 Holes	<b>CL-310DS-39</b> 39 rake to 39 level 2" x 37 <sup>3</sup> / <sub>8</sub> "	<b>CL-310DL-39</b> 39 rake to 39 level 2" x 37 <sup>3</sup> / <sub>8</sub> "	<b>CL-310DR-39</b> 39 rake to 39 level 2" x 37 <sup>3</sup> / <sub>8</sub> "
11&12 Holes	<b>CL-310D39S-42*</b> 39 rake to 42 level 2" x 40 <sup>3</sup> / <sub>8</sub> "	<b>CL-310D39L-42*</b> 39 rake to 42 level 2" x 40 <sup>3</sup> / <sub>8</sub> "	<b>CL-310D39R-42*</b> 39 rake to 42 level 2" x 40 <sup>3</sup> / <sub>8</sub> "

\*Requires a gooseneck handrail fitting

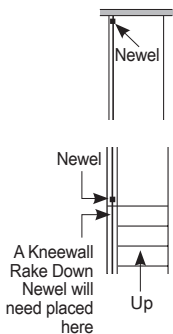

Each Metal Newel Post comes with 2 1/2" foot lag screws for attachment to the mounting surface and 1" wood screws for attachment to the handrail.

Installation Instructions are available on our website  
www.LJSmith.com

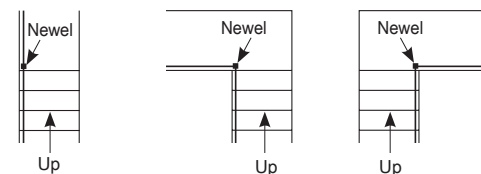

See page 14 for cable, cable fittings and cable accessories. This system is for interior or exterior use.

**IMPORTANT:** Our Metal Newels and Cable System is designed for stairways with 7-1/2" rise and 10" run (approx. 36.9°)

# METAL NEWELS & CABLE SYSTEM

## Open Tread Stairway Anatomy

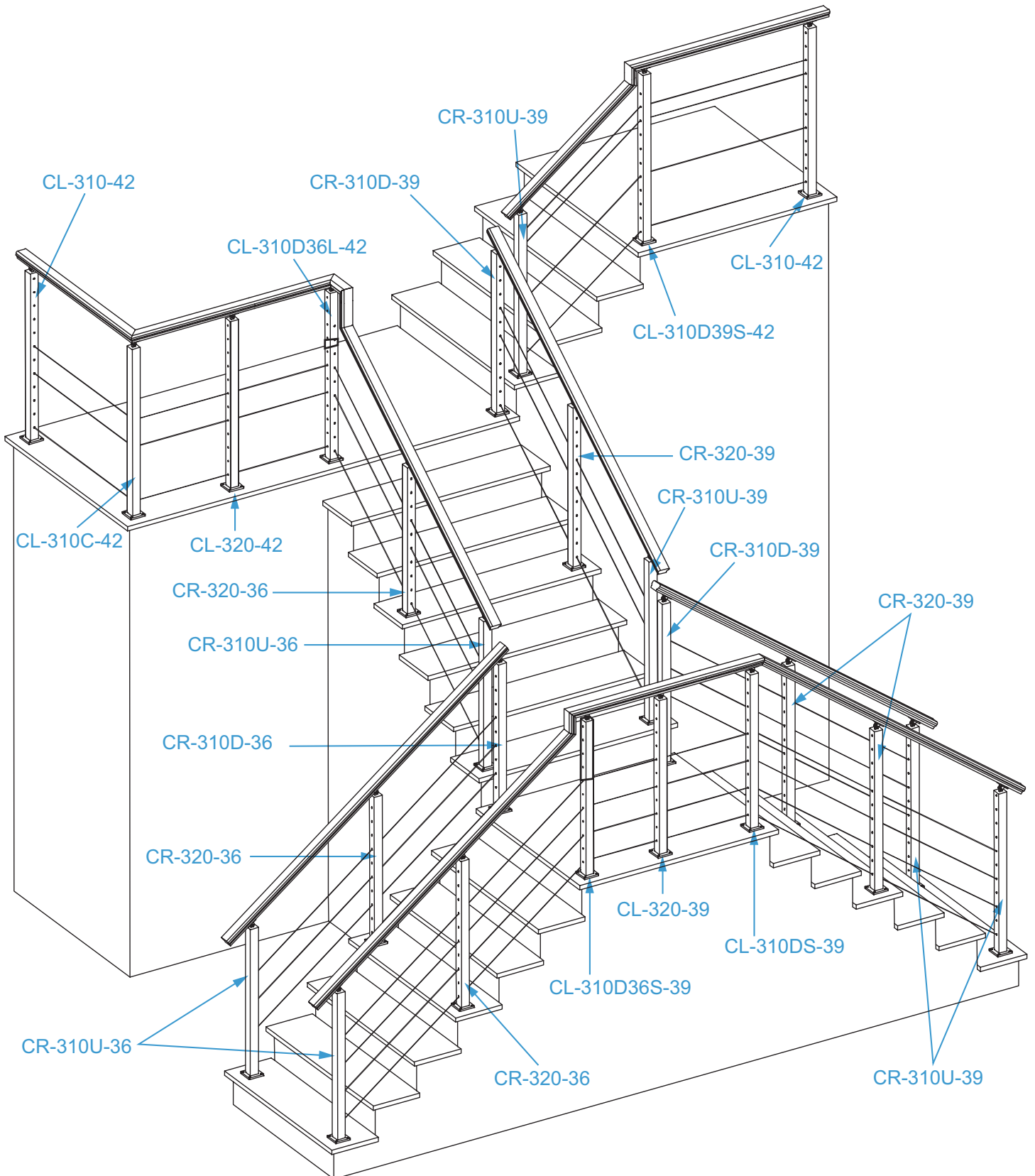



## Kneewall Stairway Anatomy

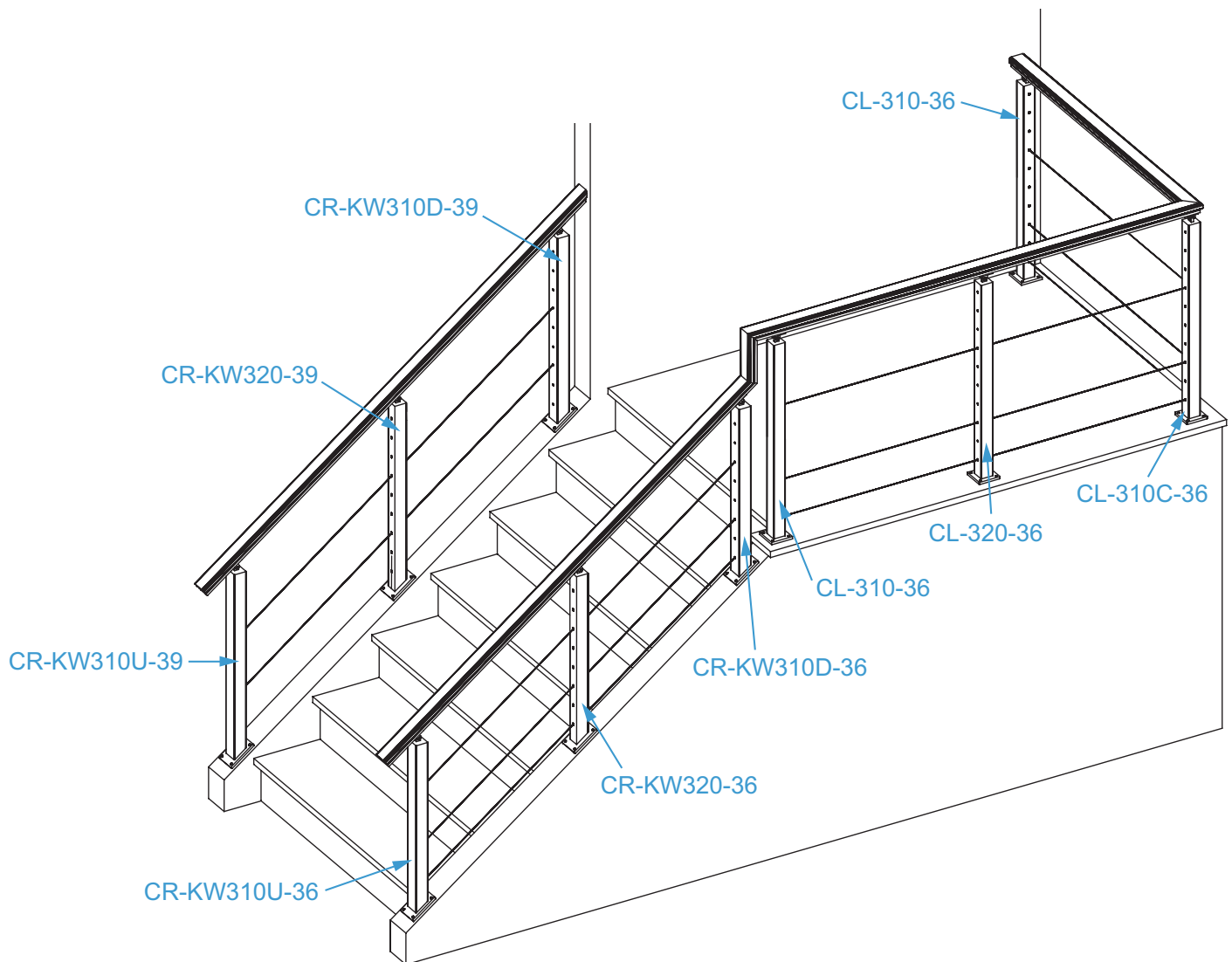

## Linear Cable System Features & Benefits

- Marine Grade 316 Stainless Steel Cable and Fittings for lasting beauty and very low maintenance
- Swageless Cable Fittings eliminate the need for expensive equipment
- Unique Linear designed newels sized and drilled for simplified installation
- Modern and code compliant handrail profile for a clean, refined look
- Box or Square Nose Treads create a modern designed stairway

# WOOD NEWELS FOR CABLE SYSTEM

## Level Run Newels

## Rake Newels

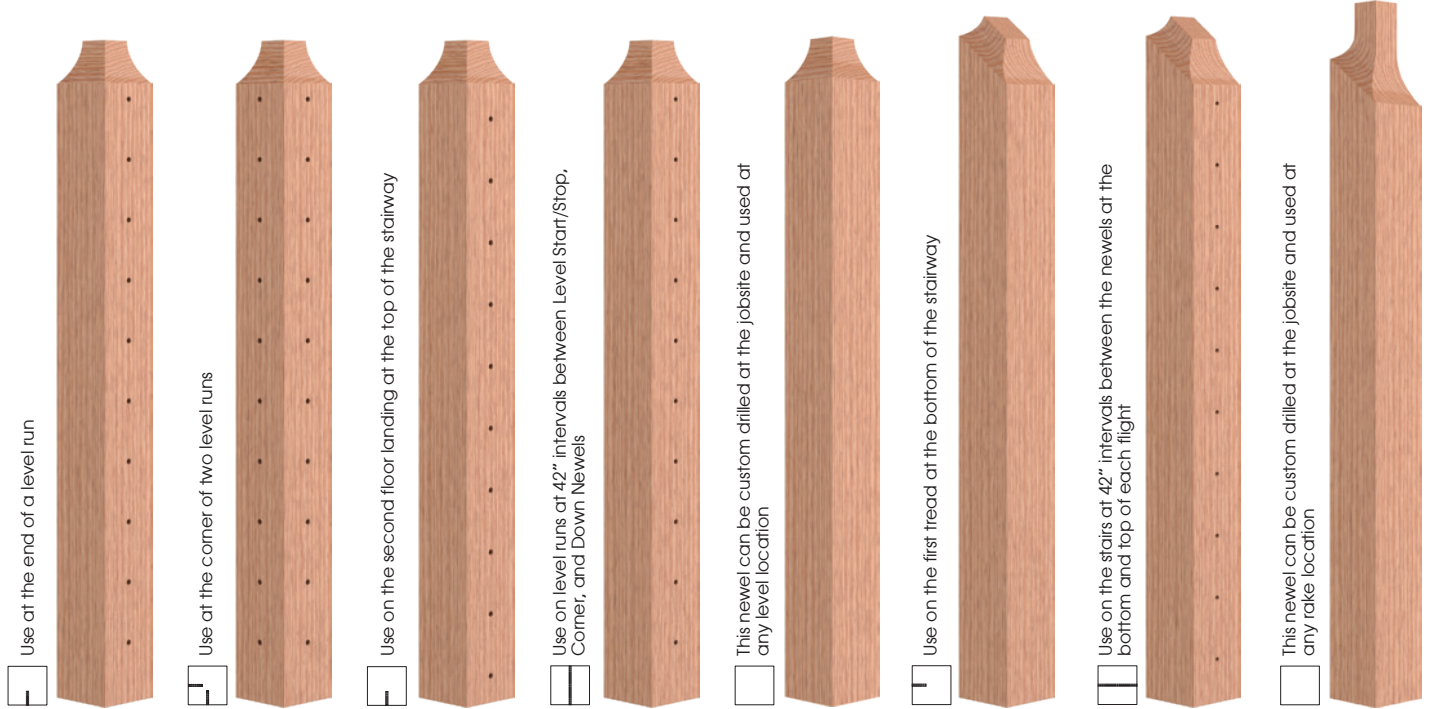

	Level Start/Stop	Level Corner	Level Down	Level Pass Through	Level Blank	Rake Up	Rake Pass Through	Rake Blank
10 Holes	<b>CL-410-36</b> 3½" x 34¾"	<b>CL-410C-36</b> 3½" x 34¾"	<b>CL-410D-36</b> 3½" x 34¾"	<b>CL-420-36</b> 3½" x 34¾"	<b>B-400-48</b> 3½" x 47½"	<b>CR-410U-36</b> 3½" x 35¾"	<b>CR-420-36</b> 3½" x 35¾"	<b>BR-400-48</b> 3½" x 47½"
11 Holes	<b>CL-410-39</b> 3½" x 37¾"	<b>CL-410C-39</b> 3½" x 37¾"	<b>CL-410D-39*</b> 3½" x 37¾"	<b>CL-420-39</b> 3½" x 37¾"		<b>CR-410U-39</b> 3½" x 38¾"	<b>CR-420-39</b> 3½" x 38¾"	
12 Holes	<b>CL-410-42</b> 3½" x 40¾"	<b>CL-410C-42</b> 3½" x 40¾"	<b>CL-410D-42*</b> 3½" x 40¾"	<b>CL-420-42</b> 3½" x 40¾"				

\* Drilled for 10 Cables

Each newel post includes a ¾" x 2" wood dowel (Dowel) for attaching the 684 Handrail

See page 14 for cable, cable fittings and cable accessories. All wood newels are for interior use only.

**IMPORTANT:** Our Wood Newels above and Cable System is designed for stairways with 7-1/2" rise and 10" run (approx. 36.9°)

## Newel Suggestions for Post to Post Systems

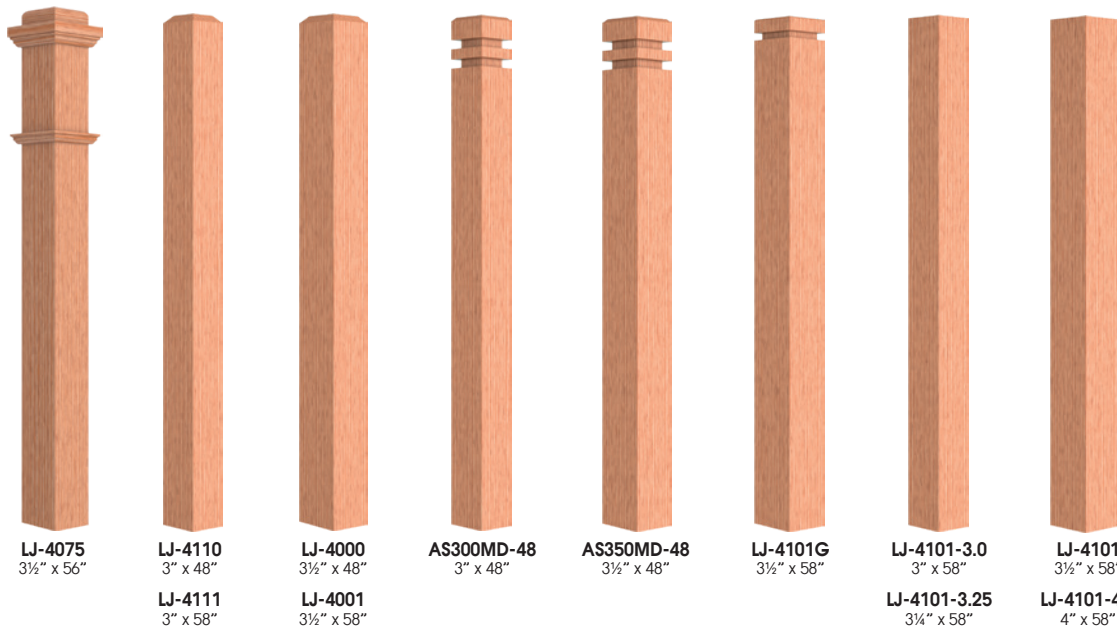

## Newel Mounting Kit for all Wood Newels

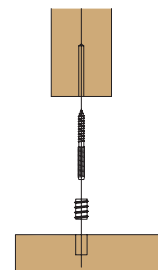

**LJ-3004-3.5**  
Hanger Bolt & Threaded Insert

# WOOD NEWELS FOR TUBE SYSTEM

## Level Run Newels

## Rake Newels

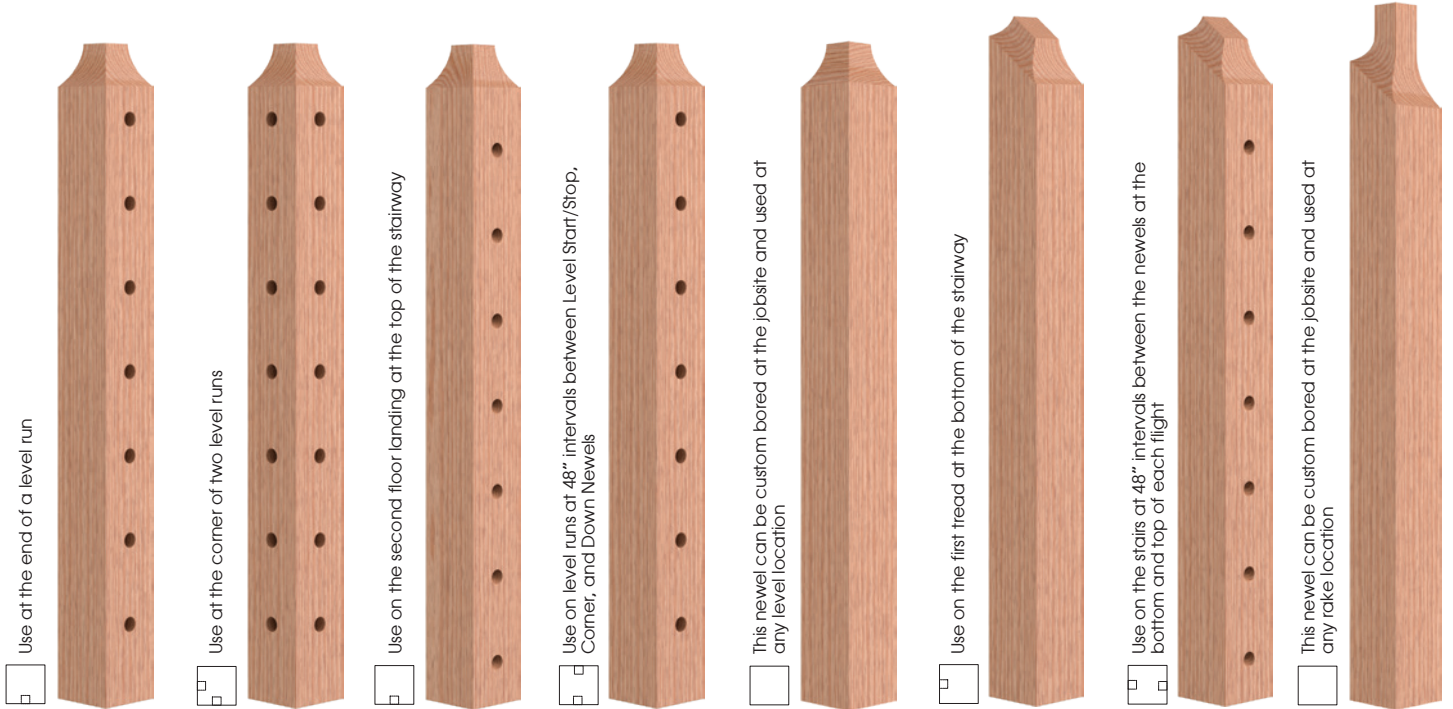

	Level Start/Stop	Level Corner	Level Down	Level Center	Level Blank	Rake Up	Rake Center	Rake Blank
7 Holes	<b>TL-410-36</b> 3½" x 34⅜"	<b>TL-410C-36</b> 3½" x 34⅜"	<b>TL-410D-36</b> 3½" x 34⅜"	<b>TL-420-36</b> 3½" x 34⅜"	<b>B-400-48</b> 3½" x 47½"	<b>TR-410U-36</b> 3½" x 35¾"	<b>TR-420-36</b> 3½" x 35¾"	<b>BR-400-48</b> 3½" x 47½"
8 Holes	<b>TL-410-39</b> 3½" x 37⅜"	<b>TL-410C-39</b> 3½" x 37⅜"	<b>TL-410D-39**</b> 3½" x 37⅜"	<b>TL-420-39</b> 3½" x 37⅜"		<b>TR-410U-39</b> 3½" x 39⅞"	<b>TR-420-39</b> 3½" x 39⅞"	
9 Holes	<b>TL-410-42</b> 3½" x 40⅜"	<b>TL-410C-42</b> 3½" x 40⅜"	<b>TL-410D-42**</b> 3½" x 40⅜"	<b>TL-420-42</b> 3½" x 40⅜"				

\*\* Drilled for 7 Tubes

Each newel post includes a ¾" x 2" wood dowel (Dowel) for attaching the 684 Handrail

Installation Instructions are available on our website at [www.LJSmith.com](http://www.LJSmith.com). This system is for interior use only.

**IMPORTANT:** Our Wood Newels above and Tube System is designd for stairways with 7-1/2" rise and 10" run (approx. 36.9°)

## Tube and Adhesive for Tube System

3/4" Hollow 304 Grade Stainless Steel Tube

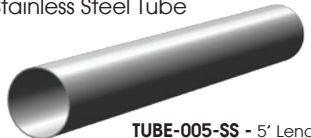

**TUBE-005-SS** - 5' Length  
**TUBE-020-SS** - 20' Length

Compatible with the predrilled newels on this page



5/8" Hollow Steel Tube  
Low Sheen Black Finish

**TUBE-58-008-LSB** - 8' Length

**Not compatible with the predrilled newels on this page. Use with Blank Newels B-400-48, BR-400-48 or any of the Post to Post Newels on the bottom of the prior page.**



**LI-3703**  
Contractor Epoxy Adhesive Mixing Nozzle

**LI-3701**  
Contractor Epoxy Adhesive

(Open work time is 18 minutes. Fills approximately 122 holes depending on hole size. Includes mixing nozzle. 28 Oz Gray. Dries Gray)

**6100E-10AD**  
Non-Sag Adhesive

(Use with a standard caulk gun cartridge. Fills approximately 110 holes depending on hole size. 10.2 Oz Clear Adhesive. Dries clear)

**EGEXTREME-10AD**  
Extreme Environmentally Friendly Adhesive

(Use with a standard caulk gun cartridge. Fills approximately 110 holes depending on hole size. 10.1 Oz White Adhesive. Dries white)

# WOOD NEWELS & CABLE SYSTEM

## Stairway Anatomy

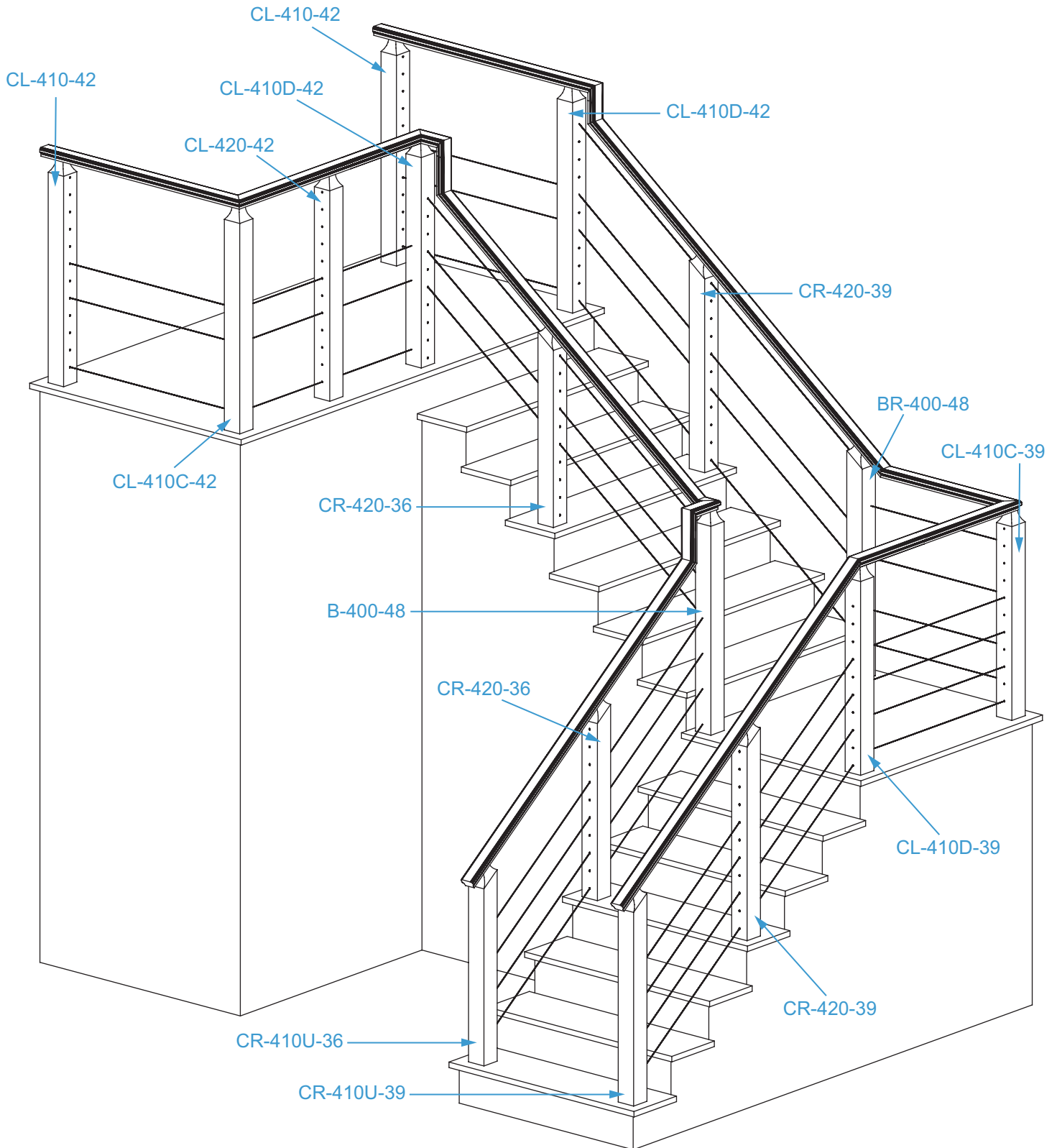

# WOOD NEWELS & TUBE SYSTEM

## Stairway Anatomy

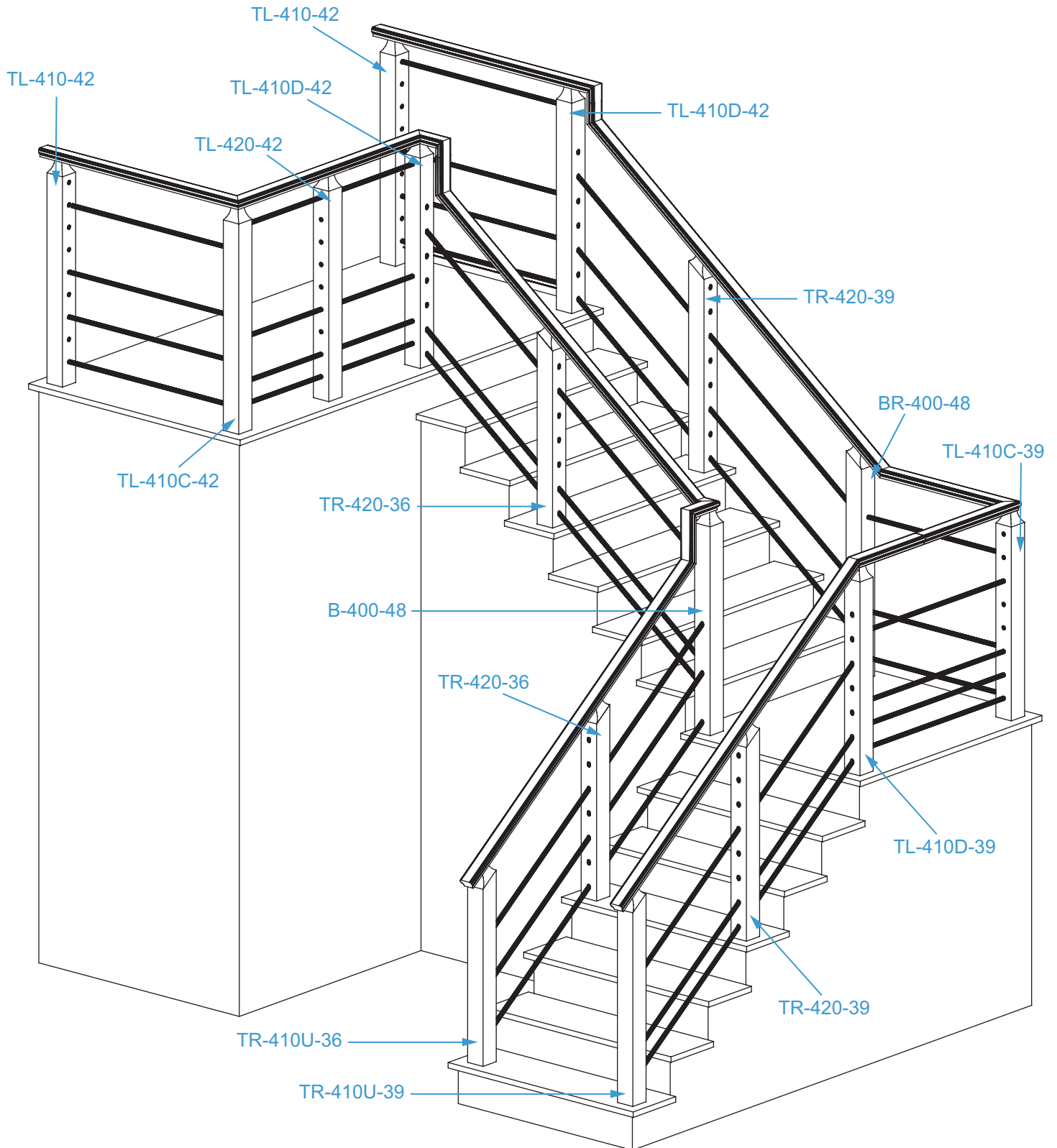



# CABLE, HANDRAIL, TREADS

## Cable Fittings for Metal Newels

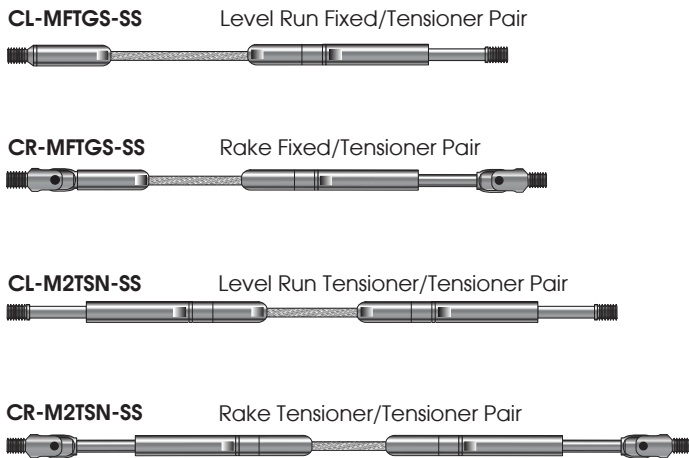

## Cable Fittings for Wood Newels

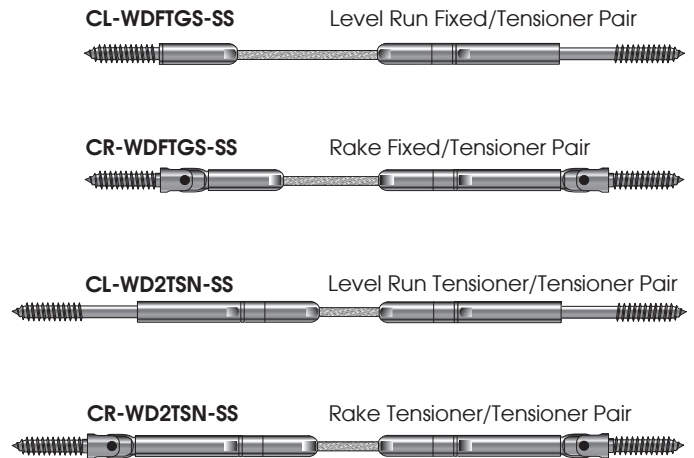

1/8" Marine Grade 316  
Stainless Steel Cable  
(1x19 construction)

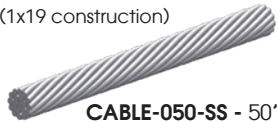

**CABLE-050-SS** - 50' Roll  
**CABLE-150-SS** - 150' Roll  
**CABLE-500-SS** - 500' Roll

Cable Release  
Tool

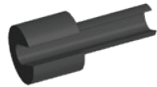

**C-RELEASE**

Cable Cutter



**C-CUTTER**

Stainless Steel  
Cleaner &  
Protectant



**C-CLEANER**

Post Protector Tube  
(For wood newels only)

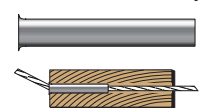

**C-PROTECTOR**

## Handrail and Handrail Fittings



**684**  
Handrail  
2 5/8" x 1 5/8"



**784QTR**  
Quarterturn



**784UE**  
Up easing



**784OE**  
Over easing



**784LHGN**  
Left Hand  
Gooseneck



**784RHGN**  
Right Hand  
Gooseneck



**784SGN**  
Straight  
Gooseneck

## Treads, Risers, Landing Tread, False Treads



**LJ-8870**  
Square Nose Plain Tread  
1" x 11-1/2"  
Lengths: 42", 48", 54"



**LJ-88701RV**  
Square Nose Tread with  
Miter Return on 1 End  
(Reversible)  
1" x 11-1/2"  
Lengths: 42", 48", 54"



**LJ-8870MR2**  
Square Nose Tread with  
Miter Return on Both  
Ends  
1" x 11-1/2"  
**QUOTED ITEM**



**LJ-8075**  
Riser  
3/4" x 7 1/2" or 8"  
Lengths: 42", 48", 54"



**BOXTRD**  
Face Laminated Solid Tread  
3-1/2" x 11-1/2"  
Lengths: 42", 48"



**LJ-8879**  
Square Nose False Tread Kit  
7-5/16" x 12-5/8"  
For open tread left hand,  
open tread right hand or  
closed tread applications.

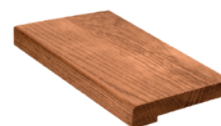

**LJ-8890-5**  
Square Nose Landing Tread  
5-1/4" x random length



**LJ-8895**  
Cove/Shoe/Trim Moulding  
3/4" x 3/4" x random length



# ORDERING GUIDELINES—

METAL PANEL  
SYSTEM



The following guidelines are designed to provide an accurate and complete list of components necessary to complete your panel railing system. This checklist and our Linear Collection Metal Panel Systems brochure will provide the flexibility to comply with most building codes as they relate to handrail height and infill spacing requirements. **The following guidelines are designed for stairways with 7 1/2" rise and 10" run (approx 36.9°)**, a rake handrail height of 36" and level handrail heights between 36" and 43" (depending on handrail used, curb wall height, amount panels are elevated, etc.). All metal panel lengths are plan view measurements. This system is for interior use only. **Consult your local building code official before purchasing and installing this system.**

Item	Guidelines	Part #	Qty.
1 TREADS	Select one tread for each step. If false treads are utilized, select one or two kits per tread depending on application.		
2 RISERS	Select one riser for each step and select one more riser per each flight.		
3 LANDING TREAD	Select sufficient lineal footage of LJ-8890-5 for the entire balcony and width of stairs at each landing. Custom landing tread can also be quoted and ordered.		
4 COVE MOULD	Applicable for level runs and stairs with risers. Select sufficient lineal footage of LJ-8895 cove moulding to go under all tread nosing (including miter returns) and under all landing tread. Cove moulding is not needed under false treads.		
5 RAKE PANELS	<b>Open Tread Stairways:</b> Select the appropriate sizes and quantity of open tread stair panels to fill the plan view layout of the open tread stairway rake. Spaces between panels can be no more than 4". Be sure to take into consideration the 1/2" thickness of each Panel Post and 1" thickness of each Spacer Newel (see 7 & 8 below) when calculating the spacing. Select from the following rake panels: (sizes indicated are plan view widths) PR-O1236 (12"), PR-O1836 (18"), PR-O2436 (24"), PR-O3036 (30"), PR-O3636 (36") <b>Kneewall Stairways:</b> Select the appropriate sizes and quantity of kneewall stair panels to fill the plan view layout of the kneewall stairway rake. Spaces between panels can be no more than 4". Be sure to take into consideration the 1" thickness of each Spacer Newel if used (see 8 below) when calculating the spacing. Select from the following rake panels: (sizes indicated are plan view widths) PR-K1236 (12"), PR-K1836 (18"), PR-K2436 (24"), PR-K3036 (30"), PR-K3636 (36")		
6 LEVEL RUN PANELS	<b>Elevated Panels:</b> Select the appropriate sizes and quantity of panels to fill the plan view layout of each level run. Spaces between panels can be no more than 4". Be sure to take into consideration the 1/2" thickness of each Panel Post and 1" thickness of each Spacer Newel (see 7 & 8 below) when calculating the spacing. Select from the following level panels for a 39" level rail height: PL-CE1239 (12"), PL-CE1839 (18"), PL-CE2439 (24"), PL-CE3039 (30"), PL-CE3639 (36"), PL-CE4239 (42"), PL-CE4839 (48"). Select from the following level panels for a 43" level rail height: PL-CE1243 (12"), PL-CE1843 (18"), PL-CE2443 (24"), PL-CE3043 (30"), PL-CE3643 (36"), PL-CE4243 (42"), PL-CE4843 (48") <b>Curb Wall Panels:</b> Select the appropriate sizes and quantity of panels to fill the plan view layout of each level run. Spaces between panels can be no more than 4". Be sure to take into consideration the 1" thickness of each Spacer Newel if used (see 8 below) when calculating the spacing. Select from the following level panels for a 39" level rail height: PL-CE1239 (12"), PL-CE1839 (18"), PL-CE2439 (24"), PL-CE3039 (30"), PL-CE3639 (36"), PL-CE4239 (42"), PL-CE4839 (48"). Select from the following level panels for a 43" level rail height: PL-CE1243 (12"), PL-CE1843 (18"), PL-CE2443 (24"), PL-CE3043 (30"), PL-CE3643 (36"), PL-CE4243 (42"), PL-CE4843 (48") <b>Flush Mount Panels:</b> Select the appropriate sizes and quantity of panels to fill the plan view layout of each level run. Spaces between panels can be no more than 4". Be sure to take into consideration the 1" thickness of each Spacer Newel if used (see 8 below) when calculating the spacing. Select from the following level panels for a 36" level rail height: PL-F1236 (12"), PL-F1836 (18"), PL-F2436 (24"), PL-F3036 (30"), PL-F3636 (36"), PL-F4236 (42"), PL-F4836 (48"). Select from the following level panels for a 39" level rail height: PL-F1239 (12"), PL-F1839 (18"), PL-F2439 (24"), PL-F3039 (30"), PL-F3639 (36"), PL-F4239 (42"), PL-F4839 (48").		
7 PANEL POSTS	Panel Posts are used on open tread stairways and elevated panel level runs. Select 2 Panel Posts with 2-Hole Foot Plate (P-POST2H) per panel. The Panel Post with 4-Hole Foot Plate (P-POST4H) is often used at the end of a level run that end near a wall.  NOTE: A Panel Post kit (P-POSTKIT2H) is available that includes: 2 Panel Posts with 2-Hole Foot Plate (P-POST2H), 4 Post Foot Lag Screws (P-POSTFTSCR2.75) and 6 Post and Barrel Bolts (P-POSTBOLT1.0).		
8 SPACER NEWELS	Spacer newels must be used in any space between panels that is over 4" to comply with building codes. Also, rake and level runs cannot exceed 15' without a spacer newel. <b>Kneewall Stairways:</b> Select the necessary quantity of Kneewall Spacer Newels (PR-K36NWL2H). <b>Level Run Elevated Panels:</b> Select the necessary quantity of Level Spacer Newels. For a 39" level rail height: PL-E39NWL4H. For a 43" level rail height: PL-E43NWL4H <b>Level Run Curb Wall Panels:</b> Select the necessary quantity of Level Spacer Newels. For a 39" level rail height: PL-C39NWL4H. For a 43" level rail height: PL-C43NWL4H <b>Level Run Flush Mount Panels:</b> Select the necessary quantity of Level Spacer Newels. For a 36" level rail height: PL-F36NWL4H. For a 39" level rail height: PL-F39NWL4H		
9 HARDWARE	Every rake and level panel comes with screws for attachment to the handrail. Screws are also included for the bottom of each panel (use for level flush mount, level curb wall mount and kneewall stair applications only). Spacer newels and panel posts include post foot lag screws. Spacer newels also include screws for attachment to the handrail. Each panel post includes 3 panel post and barrel fasteners. The panel post kit includes 6 panel post and barrel fasteners and 4 post foot lag screws. Each of these hardware items are also available separately, if needed. See pages 2 & 4.		
10 HANDRAIL	Select 684 handrail at a rate of 13" per each tread and include enough for all level runs and walls (if wall rail is required). Handrail is available in 8', 10', 12', 14', & 16' lengths.		
11 HANDRAIL GOOSENECK FITTINGS	A gooseneck handrail fitting must be used for the following rake to level run transitions: 36" rake to 39" level; 36" rake to 42" level; 39" rake to 42" level. Select the appropriate gooseneck fitting: 784LHGN (Left Hand Gooseneck), 784RHGN (Right Hand Gooseneck), 784SGN (Straight Gooseneck)		
12 HANDRAIL FITTINGS (Miscellaneous Components)	Select the necessary Overeasing, Upeasing and Level Quarterturns as needed for changes in elevation and/or direction of the handrail. If continuous handrail is needed to transition from the rake, around a wall, and continue up the stair as wall rail, select two Level Quarterturns. Select from these fittings: 784OE (Overeasing), 784UE (Upeasing), 784QTR (Level Quarterturn)		

# ORDERING GUIDELINES—

METAL NEWELS &  
CABLE SYSTEM



The following guidelines are designed to provide an accurate and complete list of components necessary to complete your metal newel post and cable railing system. This checklist and our Linear Collection brochure will provide the flexibility to comply with most building codes as they relate to handrail height and infill spacing requirements. **The following guidelines are designed for stairways with 7 1/2" rise and 10" run (approx 36.9°)**, a rake handrail height of 34"-38" and a level handrail height of 36", 39" or 42". These guidelines also follow our recommendation of installing a newel at every corner or change in direction making each straight run having separate cable with a fixed cable fitting on one end and a tensioner cable fitting on the other end into the newel posts. Tensioner cable fittings should be used on both ends of **any** cable run that is 25' to 50' long. Wood components are for interior use only. Cable, cable fittings and metal newels are for interior or exterior use. **Consult your local building code official before purchasing and installing this system.**

Item	Guidelines	Part #	Qty.
1 TREADS	Select one tread for each step. If false treads are utilized, select one or two kits per tread depending on application. (Interior stairs only)		
2 RISERS	Select one riser for each step and select one more riser per each flight. (Interior stairs only)		
3 LANDING TREAD	Select sufficient lineal footage of LJ-8890-5 landing tread for the entire balcony and width of stairs at each landing. Custom landing tread can also be quoted and ordered. (Interior stairs only)		
4 COVE MOULD	Applicable for level runs and stairs with risers. Select sufficient lineal footage of LJ-8895 cove moulding to go under all tread nosing (including miter returns) and under all landing tread. Cove moulding is not needed under false treads. (Interior stairs only)		
5 RAKE UP NEWEL	<b>Open Tread Stairways:</b> For stairs with a 34"-36" rake rail height, select the CR-310U-36 at the bottom of the stair flight. For 36"-38" rake rail height, select the CR-310U-39. If the stairway is open on both sides, two of these newels will be needed. See the Linear Metal Newel Applications chart at the bottom of this page for further information. <b>Kneewall Stairways:</b> For stairs with a 34"-36" rake rail height, select the CR-KW310U-36 at the bottom of the stair flight. For 36"-38" rake rail height, select the CR-KW310U-39. If the stairway is open on both sides, two of these newels will be needed. See the Linear Metal Newel Applications chart at the bottom of this page for further information.		
6 RAKE PASS THROUGH NEWEL	<b>Open Tread Stairways:</b> The distance between the rake newels should not exceed 42". Use in the middle of a rake run of handrail to keep the spacing between the newel posts at 42" or less. For stairs with a 34"-36" rake rail height, select the CR-320-36. For 36"-38" rake rail height, select the CR-320-39. <b>Kneewall Stairways:</b> The distance between the rake newels should not exceed 42". Use in the middle of a rake run of handrail to keep the spacing between the newel posts at 42" or less. For stairs with a 34"-36" rake rail height, select the CR-KW320-36. For 36"-38" rake rail height, select the CR-KW320-39.		
7 RAKE DOWN NEWEL	<b>Open Tread Stairways:</b> Use this newel at the top of any open tread stair flight that ends at a wall. For stairs with a 34"-36" rake rail height, select the CR-310D-36. For stairs with a 36"-38" rake rail height, select the CR-310D-39. <b>Kneewall Stairways:</b> Use this newel at the top of any kneewall stair flight. For stairs with a 34"-36" rake rail height, select the CR-KW310D-36. For stairs with a 36"-38" rake rail height, select the CR-KW310D-39.		
8 LEVEL DOWN NEWEL	<b>Open Tread Stairways Only:</b> There are three different types of Level Down Newels for use at the top of open tread stairways at the second floor landing. Based on the application details below, please select the appropriate second floor landing newel(s). <b>Transition from stair rake and continues straight to a level run:</b> For 34"-36" rake rail height transitioning to 36" level rail height select the CL-310DS-36. For 34"-36" rake rail height transitioning to 39" level rail height select the CL-310D36S-39. For 34"-36" rake rail height transitioning to 42" level rail height select the CL-310D36S-42. For 36"-38" rake rail height transitioning to 39" level rail height select the CL-310DS-39. For 36"-38" rake rail height transitioning to 42" level rail height select the CL-310D39S-42. <b>Transition from stair rake and turns left to a level run:</b> For 34"-36" rake rail height transitioning to 36" level rail height select the CL-310DL-36. For 34"-36" rake rail height transitioning to 39" level rail height select the CL-310D36L-39. For 34"-36" rake rail height transitioning to 42" level rail height select the CL-310D36L-42. For 36"-38" rake rail height transitioning to 39" level rail height select the CL-310DL-39. For 36"-38" rake rail height transitioning to 42" level rail height select the CL-310D39L-42. <b>Transition from stair rake and turns right to a level run:</b> For 34"-36" rake rail height transitioning to 36" level rail height select the CL-310DR-36. For 34"-36" rake rail height transitioning to 39" level rail height select the CL-310D36R-39. For 34"-36" rake rail height transitioning to 42" level rail height select the CL-310D36R-42. For 36"-38" rake rail height transitioning to 39" level rail height select the CL-310DR-39. For 36"-38" rake rail height transitioning to 42" level rail height select the CL-310D39R-42.		
9 LEVEL CORNER NEWEL	For 36" level rail height, select the CL-310C-36 for the newel at the corner of two level runs. For 39" level rail height, select the CL-310C-39. For 42" level rail height, select the CL-310C-42.		
10 LEVEL START/STOP NEWEL	Cable fittings may be installed directly into the wall at the end of a level run, or they can be installed into a newel post at the end of the run that is placed next to the wall. If ending a level run with a newel post, select the CL-310-36 for 36" level rail height. Select the CL-310-39 for 39" level rail height. Select the CL-310-42 for 42" level rail height. These newels are also used to start the level run that transitions from the top of a kneewall stair flight.		
11 LEVEL PASS THROUGH NEWEL	The distance between the level run newels should not exceed 42". Use the Level Pass Through Newel at 42" intervals in the middle of a level run. For 36" level rail height, select the CL-320-36. For 39" level rail height, select the CL-320-39. For 42" level rail height, select the CL-320-42.		
12 RAKE FIXED/TENSIONER CABLE FITTINGS PAIR (CR-MFTGS-SS)	Each rake cable run requires a CR-MFTGS-SS (Rake Fixed/Tensioner Pair). Calculate the total number of rake cable fitting pairs needed based on the Rake Up Newel(s) selected in #4 above. Be sure to include enough cable fitting pairs for each flight. Do not include Rake Pass Through Newels (CR-320) when calculating cable fitting sets required since the cable will simply "pass through" this newel. <b>Open Tread Stairways:</b> CR-310U-36 requires 10 pairs; CR-310U-39 requires 11 pairs <b>Kneewall Stairways:</b> CR-KW310U-36 requires 8 pairs; CR-KW310U-39 requires 9 pairs For any cable run of 25' to 50' long, tensioner cable fittings should be used on both ends of the cable to achieve the desired tensioning on both directions of cable. Item CR-M2TSN-SS contains 2 Rake Tensioners.		
13 LEVEL RUN FIXED/TENSIONER CABLE FITTINGS PAIR (CL-MFTGS-SS)	Each level cable run requires a CL-MFTGS-SS (Level Fixed/Tensioner Pair). Calculate the level cable fitting pairs needed by taking the number of straight level runs times the number of pairs required for the selected newels. CL-310-36 requires 10 pairs; CL-310-39 requires 11 pairs; CL-410-42 requires 12 pairs. Do not include Level Pass Through Newels (CL-320) when calculating cable fitting sets required since the cable will simply "pass through" this newel. For any cable run of 25' to 50' long, tensioner cable fittings should be used on both ends of the cable to achieve the desired tensioning on both directions of cable. Item CL-M2TSN-SS contains 2 Level Run Tensioners.		
14 1/8" CABLE	Calculate enough cable to run between every Fixed/Tensioner Cable Fitting Pair as well as between every Tensioner/Tensioner Cable Fitting Pair. Cable runs should be no longer than 50'. Cable is available in 50' (CABLE-050-SS), 150' (CABLE-150-SS) and 500' (CABLE-500-SS) spools.		
15 HANDRAIL	Select 684 handrail at a rate of 13" per each tread and include enough for all level runs and walls (if wall rail is required). Handrail is available in 8', 10', 12', 14', & 16' lengths. (Interior stairs only, however exterior 684 can be quoted)		
16 HANDRAIL GOOSENECK FITTINGS	A gooseneck handrail fitting must be used for the following rake to level run transitions: 36" rake to 39" level; 36" rake to 42" level; 39" rake to 42" level. Select the appropriate gooseneck fitting: 784LHGN (Left Hand Gooseneck), 784RHGN (Right Hand Gooseneck), 784SGN (Straight Gooseneck) (Interior stairs only, however exterior gooseneck fittings can be quoted)		
17 HANDRAIL FITTINGS (Miscellaneous Components)	Select the necessary Overeasing, Upeasing and Level Quarterturns as needed for changes in elevation and/or direction of the handrail. If continuous handrail is needed to transition from the rake, around a wall, and continue up the stair as wall rail, select two Level Quarterturns. Select from these fittings: 784OE (Overeasing), 784UE (Upeasing), 784QTR (Level Quarterturn) (Interior stairs only, however exterior handrail fittings can be quoted)		
18 ACCESSORIES	Select a Cable Release Tool (C-RELEASE), Cable Cutters (C-CUTTER), Stainless Steel Cleaner & Protectant (C-CLEANER).		

## Linear Metal Newel Applications

Open Tread Rake Up Newel (CR-310U)	Use this newel as the starting newel on the first tread at the bottom of an open tread stairway flight.
Open Tread Rake Pass Through Newel (CR-320)	Use this newel on open tread stairs at 42" intervals between the newels at the bottom and top of each flight.
Open Tread Rake Down Newel (CR-310D)	Use this newel at the top of the first flight of any L-shaped open tread stairway. Also used at the top of any flight that ends at a wall.
Kneewall Rake Up Newel (CR-KW310U)	Use this newel as the starting newel on the first tread at the bottom of a kneewall stairway flight.
Kneewall Rake Pass Through Newel (CR-KW320)	Use this newel on kneewall stairs at 42" intervals between the newels at the bottom and top of each flight.
Kneewall Rake Down Newel (CR-KW310D)	Use this newel at the top of any kneewall stairway flight.
Level Start/Stop Newel (CL-310)	Use this newel at the beginning or end of each level run. Also used on the level run that transitions from a kneewall stair flight.
Level Pass Through Newel (CL-320)	Use this newel on level runs midway between the Level Start/Stop, Level Corner and Level Down Newels at 42" intervals.
Level Corner Newel (CL-310C)	Use this newel at the corner of two level runs.
Level Down to Level Straight Newel (CL-310DS)	Use this newel on the second floor landing at the top of the stairway flight that transitions to a straight level run.
Level Down to Level Left Newel (CL-310DL)	Use this newel on the second floor landing at the top of the stairway flight that transitions left to a level run.
Level Down to Level Right Newel (CL-310DR)	Use this newel on the second floor landing at the top of the stairway flight that transitions right to a level run.

The following guidelines are designed to provide an accurate and complete list of components necessary to complete your wood newel post and cable or tube railing system. This checklist and our Linear Collection brochure will provide the flexibility to comply with most building codes as they relate to handrail height and infill spacing requirements. **The following guidelines are designed for stairways with 7 1/2" rise and 10" run (approx 36.9°)**, a rake handrail height of 34"-38" and a level handrail height of 36", 39" or 42". These guidelines also follow our recommendation of installing a newel at every corner or change in direction making each straight run separate cable with a fixed cable fitting on one end and a tensioner cable fitting on the other end into the newel posts. However, you can run cable through two Pass Through Newels (positioned at 45° from one another) with Post Protector Tubes to turn a corner, but tensioner cable fittings must be used on both ends of the cable to achieve the desired tensioning on both directions of cable. Tensioner cable fittings should also be used on both ends of any cable run that is 25' to 50' long. These systems are for interior use only. **Consult your local building code official before purchasing and installing this system.**

Item	Guidelines	Part #	Qty.
1	<b>TREADS</b> Select one tread for each step. If false treads are utilized, select one or two kits per tread depending on application.		
2	<b>RISERS</b> Select one riser for each step and select one more riser per each flight.		
3	<b>LANDING TREAD</b> Select sufficient lineal footage of LJ-8890-5 for the entire balcony and width of stairs at each landing. Custom landing tread can also be quoted and ordered.		
4	<b>COVE MOULD</b> Applicable for level runs and stairs with risers. Select sufficient lineal footage of LJ-8895 cove moulding to go under all tread nosing (including miter returns) and under all landing tread. Cove moulding is not needed under false treads.		
5	<b>RAKE UP NEWEL</b> <b>CABLE SYSTEM:</b> For stairs with a 34"-36" rake rail height, select the CR-410U-36 at the bottom of the stairway at the first floor. For 36"-38" rake rail height, select the CR-410U-39. If the stairway is open on both sides, two of these newels will be needed. See the Wood Linear Newel Applications chart at the bottom of this page for further information. <b>TUBE SYSTEM:</b> For stairs with a 34"-36" rake rail height, select the TR-410U-36 at the bottom of the stairway at the first floor. For 36"-38" rake rail height, select the TR-410U-39. If the stairway is open on both sides, two of these newels will be needed. See the Wood Linear Newel Applications chart at the bottom of this page for further information.		
6	<b>RAKE PASS THROUGH NEWEL (Cable)</b> <b>CABLE SYSTEM:</b> The distance between the rake newels should not exceed 42". Use in the middle of a rake run of handrail to keep the spacing between the newel posts at 42" or less. For stairs with a 34"-36" rake rail height, select the CR-420-36. For 36"-38" rake rail height, select the CR-420-39. <b>RAKE CENTER NEWEL (Tube)</b> <b>TUBE SYSTEM:</b> The distance between the rake newels should not exceed 48". Use in the middle of a rake run of handrail to keep the spacing between the newel posts at 48" or less. For stairs with a 34"-36" rake rail height, select the TR-420-36. For 36"-38" rake rail height, select the TR-420-39.		
7	<b>LEVEL DOWN NEWEL</b> <b>CABLE SYSTEM:</b> For 36" level rail height, select the CL-410D-36 for the newel on the second floor landing at the top of the stairway flight. For 39" level rail height, select the CL-410D-39. For 42" level rail height, select the CL-410D-42. <b>TUBE SYSTEM:</b> For 36" level rail height, select the TL-410D-36 for the newel on the second floor landing at the top of the stairway flight. For 39" level rail height, select the TL-410D-39. For 42" level rail height, select the TL-410D-42.		
8	<b>LEVEL CORNER NEWEL</b> <b>CABLE SYSTEM:</b> For 36" level rail height, select the CL-410C-36 for the newel at the corner of two level runs. For 39" level rail height, select the CL-410C-39. For 42" level rail height, select the CL-410C-42. <b>TUBE SYSTEM:</b> For 36" level rail height, select the TL-410C-36 for the newel at the corner of two level runs. For 39" level rail height, select the TL-410C-39. For 42" level rail height, select the TL-410C-42.		
9	<b>LEVEL START/STOP NEWEL</b> <b>CABLE SYSTEM:</b> Cable fittings may be installed directly into the wall at the end of a level run, or they can be installed into a newel post at the end of the run that is placed next to the wall. If ending a level run with a newel post, select the CL-410-36 for 36" level rail height. Select the CL-410-39 for 39" level rail height. Select the CL-410-42 for 42" level rail height. <b>TUBE SYSTEM:</b> Tube should be installed into a newel post at the end of the level run that is placed next to the wall. Select the TL-410-36 for 36" level rail height. Select the TL-410-39 for 39" level rail height. Select the TL-410-42 for 42" level rail height.		
10	<b>LEVEL PASS THROUGH NEWEL (Cable)</b> <b>CABLE SYSTEM:</b> The distance between the level run newels should not exceed 42". Use the Level Pass Through Newel at 42" intervals in the middle of a level run. For 36" level rail height, select the CL-420-36. For 39" level rail height, select the CL-420-39. For 42" level rail height, select the CL-420-42. <b>LEVEL CENTER NEWEL (Tube)</b> <b>TUBE SYSTEM:</b> The distance between the level run newels should not exceed 48". Use the Center Newel at 48" intervals in the middle of a long level run. For 36" level rail height, select the TL-420-36. For 39" level rail height, select the TL-420-39. For 42" level rail height, select the TL-420-42.		
11	<b>BLANK NEWEL</b> Blank newels are used when the location of the drilled holes needs to be different from the predrilled holes in our standard Linear Collection newels. Use the B-400-48 at the corner of an intermediate landing and at any level position. Use the BR-400-48 at any rake location.		
12	<b>NEWEL MOUNTING KIT</b> Select one LJ-3004-3.5 newel mounting kit for each newel post.		
13	<b>RAKE FIXED/TENSIONER CABLE FITTINGS PAIR (CR-WDFTGS-SS)</b> <b>CABLE SYSTEM:</b> To ensure performance of our system, a stabilizing member such as our 3/4" tube or 1 1/4" S4S wood is required between all newel posts at the top pre-drilled position. Each rake cable run requires a CR-WDFTGS-SS (Rake Fixed/Tensioner Pair). Calculate the total number of rake cable fitting pairs needed based on the cable system Rake Up Newel(s) selected in #5 above. CR-410U-36 requires 9 pairs when installing a stabilizing member at the top position (10 pairs without stabilizing member); CR-410U-39 requires 10 pairs when installing a stabilizing member at the top position (11 pairs without stabilizing member). Be sure to include enough cable fitting pairs for each flight. Do not include Rake Pass Through Newels (CR-420) when calculating cable fitting sets required since the cable will simply "pass through" this newel. Any cable run of 25' to 50', or if the cable runs through Pass Through Newels to make a change in direction or elevation, tensioner cable fittings should be used on both ends of the cable to achieve the desired tensioning on both directions of cable. Item CR-WD2TSN-SS contains 2 Rake Tensioners.		
14	<b>LEVEL RUN FIXED/TENSIONER CABLE FITTINGS PAIR (CL-WDFTGS-SS)</b> <b>CABLE SYSTEM:</b> To ensure performance of our system, a stabilizing member such as our 3/4" tube or 1 1/4" S4S wood is required between all newel posts at the top pre-drilled position. Each level cable run requires a CL-WDFTGS-SS (Level Fixed/Tensioner Pair). Calculate the level cable fitting pairs needed by taking the number of straight level runs times the number of pairs required for the selected cable system level newels. CL-410-36 requires 9 pairs when installing a stabilizing member at the top position (10 pairs without stabilizing member); CL-410-39 requires 10 pairs when installing a stabilizing member at the top position (11 pairs without stabilizing member); CL-410-42 requires 11 pairs when installing a stabilizing member at the top position (12 pairs without stabilizing member). Do not include Level Pass Through Newels (CL-420) when calculating cable fitting sets required since the cable will simply "pass through" this newel. Any cable run of 25' to 50', or if the cable runs through Pass Through Newels to make a change in direction or elevation, tensioner cable fittings should be used on both ends of the cable to achieve the desired tensioning on both directions of cable. Item CL-WD2TSN-SS contains 2 Level Run Tensioners.		
15	<b>POST PROTECTOR TUBE</b> <b>CABLE SYSTEM:</b> Select a C-PROTECTOR (Post Protector Tube) for every instance where the cable enters or exits a Level Pass Through Newel at an angle. Post Protector Tubes keep the cable from biting into the wood.		
16	<b>1/8" CABLE</b> <b>CABLE SYSTEM:</b> Calculate enough cable to run between every Fixed/Tensioner Cable Fitting Pair as well as between every Tensioner/Tensioner Cable Fitting Pair. Cable runs should be no longer than 50'. Cable is available in 50' (CABLE-050-SS), 150' (CABLE-150-SS) and 500' (CABLE-500-SS) spools.		
17	<b>3/4" TUBE</b> <b>CABLE SYSTEM:</b> If using 3/4" Tube as a stabilizing member between newels in a cable system, select enough tube to run between each newel. <b>TUBE SYSTEM:</b> Select enough tube to run between every tube system newel selected. TR/TL-410/420-36 requires 7 tubes; TR/TL-410/420-39 requires 8 tubes; TL-410/420-42 requires 9 tubes. Tube is available in 5' (TUBE-005-SS) or 20' (TUBE-020-SS) lengths.		
18	<b>HANDRAIL</b> Select 684 handrail at a rate of 13" per each tread and include enough for all level runs and walls (if wall rail is required). Handrail is available in 8', 10', 12', 14', & 16' lengths.		
19	<b>HANDRAIL GOOSENECK FITTINGS</b> A gooseneck handrail fitting must be used for the following rake to level run transitions: 36" rake to 39" level; 36" rake to 42" level; 39" rake to 42" level. Select the appropriate gooseneck fitting: 784LHGN (Left Hand Gooseneck), 784RHGN (Right Hand Gooseneck), 784SGN (Straight Gooseneck)		
20	<b>HANDRAIL FITTINGS (Miscellaneous Components)</b> Select the necessary Overeasing, Upeasing and Level Quarterturns as needed for changes in elevation and/or direction of the handrail. If continuous handrail is needed to transition from the rake, around a wall, and continue up the stair as wall rail, select two Level Quarterturns. Select from these fittings: 784OE (Overeasing), 784UE (Upeasing), 784QTR (Level Quarterturn)		
21	<b>ACCESSORIES</b> <b>CABLE SYSTEM:</b> Select a Cable Release Tool (C-RELEASE), Cable Cutters (C-CUTTER), Stainless Steel Cleaner & Protectant (C-CLEANER). <b>TUBE SYSTEM:</b> Select Stainless Steel Cleaner & Protectant (C-CLEANER), and select one of these adhesives: Epoxy and Nozzle (LI-3701 & LI-3703), Non-Sag Adhesive (6100E-10AD), Environmentally Friendly Adhesive (EGEXTREME-10AD)		

## Linear Wood Newel Applications

<b>Rake Up Newel</b> (Cable: CR-410U) (Tube: TR-410U)	Use this newel as the starting newel on the first tread at the bottom of the stairway
<b>Rake Pass Through/Center Newel</b> (Cable: CR-420) (Tube: TR-420)	Use this newel on the stairs at 42"(cable)/48"(tube) intervals between the newels at the bottom and top of each flight
<b>Level Start/Stop Newel</b> (Cable: CL-410) (Tube: TL-410)	Use this newel at the beginning or end of each level run
<b>Level Corner Newel</b> (Cable: CL-410C) (Tube: TL-410C)	Use this newel at the corner of two level runs
<b>Level Down Newel</b> (Cable: CL-410D) (Tube: TL-410D)	Use this newel on the second floor landing at the top of the stairway flight
<b>Level Pass Through/Center Newel</b> (Cable: CL-420) (Tube: TL-420)	Use this newel on level runs midway between the Level Start/Stop, Corner and Down Newels at 42"(cable)/48"(tube) intervals
<b>Blank Newel</b> (Cable & Tube: B-400-48)	This newel is not pre-drilled and can be custom drilled at the jobsite and used at any level location
<b>Rake Blank Newel</b> (Cable & Tube: BR-400-48)	This newel is not pre-drilled and can be custom drilled at the jobsite and used at any rake location



# PHOTO PORTFOLIO



**1** Open Tread Stair Panels, Level Run Panels, P-POSTKIT2H Panel Post Kits and Custom Handrail

**2** Linear CABLE-SS Stainless Steel Cable, CL-MFTGS-SS Stainless Steel Level Run Cable Fittings, CL-310-36, CL-310C-36 and CL-320-36 Linear Metal Newel Posts and exterior rail supplied by others

**3** Linear TUBE-SS Stainless Steel Tube, TL-420-36 Level Center Newel Posts and 684 Handrail

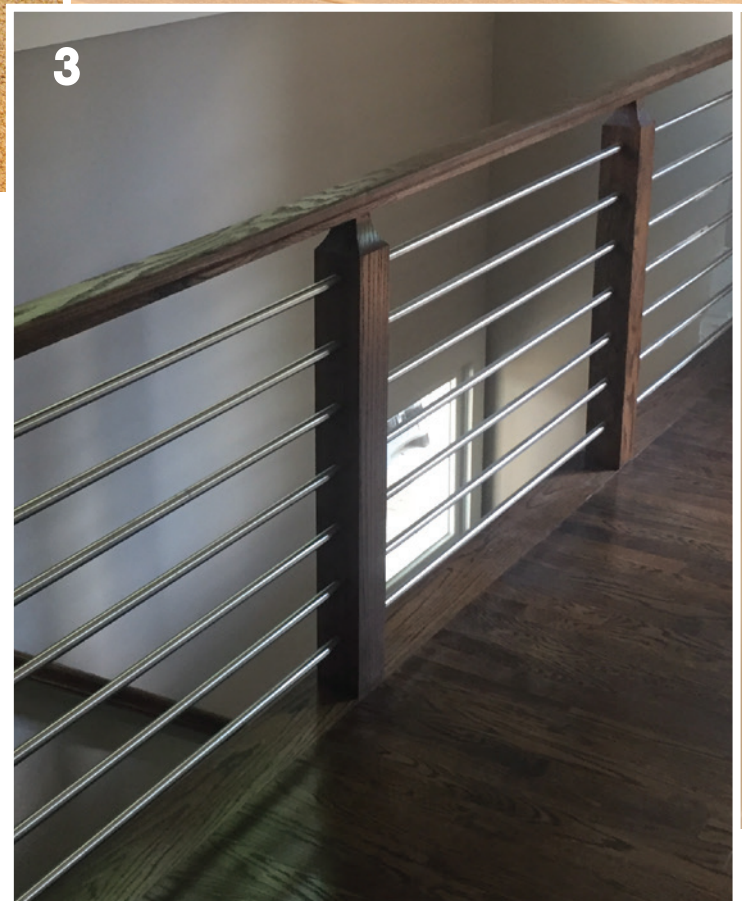



**4** Kneewall Stair Panels, Level Run Panels, LJ-4101G Newel Posts and Custom Handrail

**5** Linear CABLE-SS Stainless Steel Cable, CL-WDFTGS-SS Level Run and CR-WDFTGS-SS Rake Stainless Steel Cable Fittings, 684 Handrail, Custom Site-built Box Newel

**6** Linear TUBE-58-008-LSB Low Sheen Black Tube, LJ-4000 Newel Posts and 684 Handrail





Consult your local building code official before purchasing and installing any of these systems. Please contact your L.J. Smith dealer or representative if you have any questions about our Linear Collection products.

## TOOLS LISTS

### PANEL SYSTEM

Power Drill  
Miter Saw  
Hack Saw  
Square or Phillips Screw Tip  
5/32" Hex Driver or Allen Wrench  
1/8", 3/16", 1/4", 3/8" Twist Bits

### CABLE & METAL NEWELS SYSTEM\*

Power Drill  
1/8" Cable Cutter  
Two 3/8" Open End Wrenches  
1/2" Box End Wrench  
3/16", 5/32" Allen Wrenches  
1/8", 1/4" Twist Bits  
#2 Phillips Drill Tip or Phillips  
Screwdriver  
Cable Release Tool

### CABLE & WOOD NEWELS SYSTEM\*

Power Drill  
1/8" Cable Cutter  
Two 3/8" Open End Wrenches  
3/16" Allen Wrench  
9/16" Wrench  
5/16" Twist Bit  
5/8" x 3" Flare Spade Bit  
Cable Release Tool

### TUBE & WOOD NEWELS SYSTEM

Power Drill  
9/16" Wrench  
5/16" Twist Bit  
5/8" x 3" Flare Spade Bit

\*The tension on the cables will need periodic adjustment by using two 3/8" open end wrenches as described in the installation instructions.



A NOVO Building Products Company

35280 Scio-Bowerston Road • Bowerston, Oh 44695  
(740) 269-2221 • LJSmith.com